



Trojan Round energy efficient IP65 2D luminaire



The **Trojan** range of energy efficient bulkhead fittings are manufactured with a polycarbonate base and diffuser. Together with a poured gasket the Trojan leads vandal-resistant IP65 technology. With a hinged gear tray, and Time-in-a-Box packaging, installation is swift and easy.

Versions

- High Frequency
- 3hr Maintained (16W & 28W)
- Clear or Opal diffuser
- Black or White base



GE Lighting 2D lamps are fitted as standard.

IP65



MANUFACTURED IN THE UK 

Fern Howard products are manufactured in the UK at our extensive facility in Bordon, Hampshire. Fittings are manufactured and tested in accordance with BS EN 60598. They are also RoHS compliant.



Trojan Round energy efficient IP65 2D luminaire



FERN-HOWARD GASKETING - POURED TO PERFECTION

Using a PC controlled contour robot, our FIPFG (Formed In Place Foam Gasket) sealing system creates a poured gasket seal.

We use two chemically safe components which are combined and expand to form a 'poured two-part gasket' which can blend any join and fill all uneven surfaces into a one piece seal.

Whenever you 'cut and splice', the join will always be a weak point in your finished product. The distinct advantage of a 'formed in place foam gasket', compared to adding any other secondary sponge material, is that it is formed and adheres to the product as a one piece application, requiring no additional fixing.

TIME-IN-A-BOX is Fern-Howard's unique packaging method, which presents component parts to the installer in exactly the order required. All parts are kept safely in the box - in protective wrappings to avoid breakages - until required, an added advantage if there is a prolonged period between first and second fix. In independently controlled and observed tests, Time-in-a-Box has been found to halve the fitting time required over a comparable luminaire, thus significantly contributing to efficiency and cost savings.

- 1 Open the box
- 2 Take out the base moulding
- 3 Attach to surface
- 4 Take out gear tray
- 5 Present to moulding
- 6 Tighten screws
- 7 Connect supply
- 8 Close gear tray
- 9 Remove lamp from protective wrapping
- 10 Clip in place
- 11 Take diffuser from box
- 12 Screw in place
- 13 Job done



Trojan Round energy efficient IP65 2D luminaire

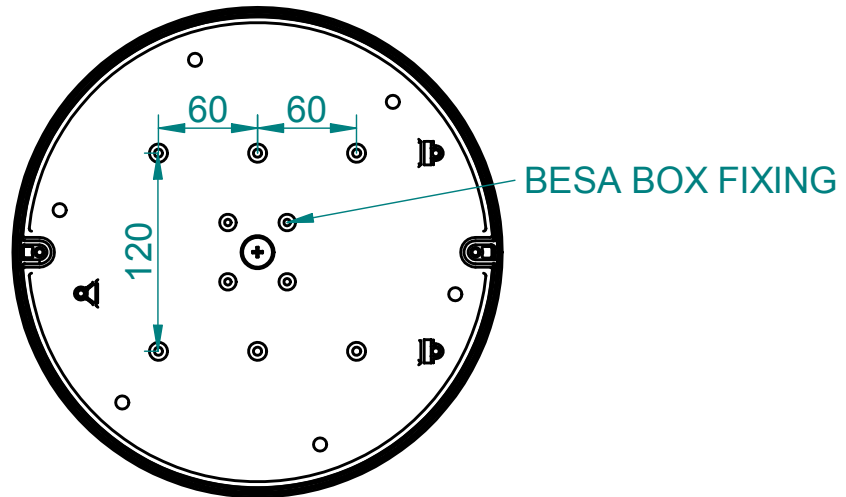

FIXING POINTS

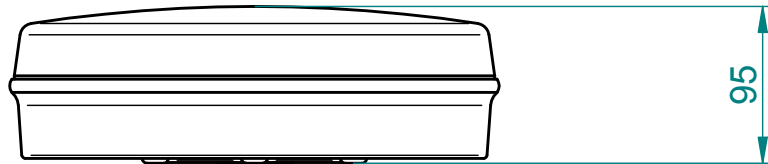

HEIGHT

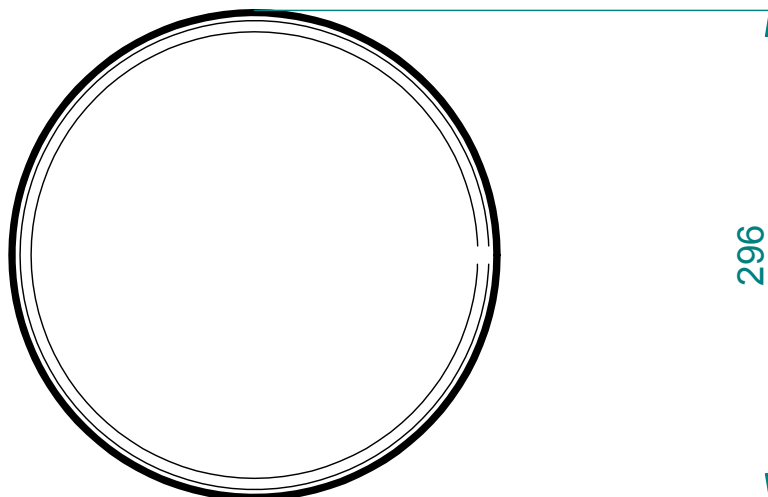

FOOTPRINT



Trojan Round energy efficient IP65 2D luminaire





Trojan Round energy efficient IP65 2D luminaire

INSTALLATION AND OPERATING INSTRUCTIONS

THIS FITTING SHOULD NOT BE USED IN AREAS EXCEEDING 25°C AMBIENT AIR TEMPERATURE

This fitting must be installed by a qualified electrician and wired in accordance with the latest edition of the IEE Electrical Regulations. Information regarding Part Number, Description, Voltage, Frequency, IP Rating and Lamp type is shown on the label affixed to the box containing the luminaire.

Pre-installation

ALWAYS TURN OFF THE MAINS SUPPLY BEFORE COMMENCING INSTALLATION

Make sure that the mains supply is compatible with the fitting.

If IP rating has to be retained a cable gland of the correct IP rating must be used and any fixing holes must be filled with a proprietary silicon sealing compound.

High voltage insulation test equipment **MUST NOT** be used on High Frequency, Emergency or Dimming luminaires.

The luminaire is suitable for use within ambient temperature range of -10° C to +25° C **ONLY**.

PIR and electronic time switches are not recommended for these luminaires. If used, ensure that there is no "Leakage Current" when in the "Off" position and an "On" time of not less than 20 minutes. Failure to ensure this could potentially impair the performance of the luminaire.

Lamp Switching Cycles / Lamp Life

CONSTANT SWITCHING REDUCES LAMP LIFE

Typical switching cycles should achieve 100% of the manufacturers stated lamp life, however, switching every 5 minutes would reduce this to 20%.

Installation

Take out the base moulding.

Drill out the cable entry and any other "Cut Outs" required.

If cut outs are required for conduit fixing (Not BESA) make sure that the hole is drilled high enough in the side of the base to allow the inside nut to be fitted.

Feed the incoming mains through the cable entry gland and secure the base to the mounting surface required using the mounting points provided (failure to do this will cause the fitting to distort) with fixings suitable to support the fitting and for the material to which the base is being attached. Put the gear tray into the Hinge position, tighten the two screws and allow the Gear tray to hinge open.

Make sure that the incoming mains cable is long enough to allow the Gear Tray to be completely opened.

Connect the incoming mains to the terminal block.

If using stranded cables, make sure that no stray wires are omitted from the terminal connection.



Trojan Round energy efficient IP65 2D luminaire

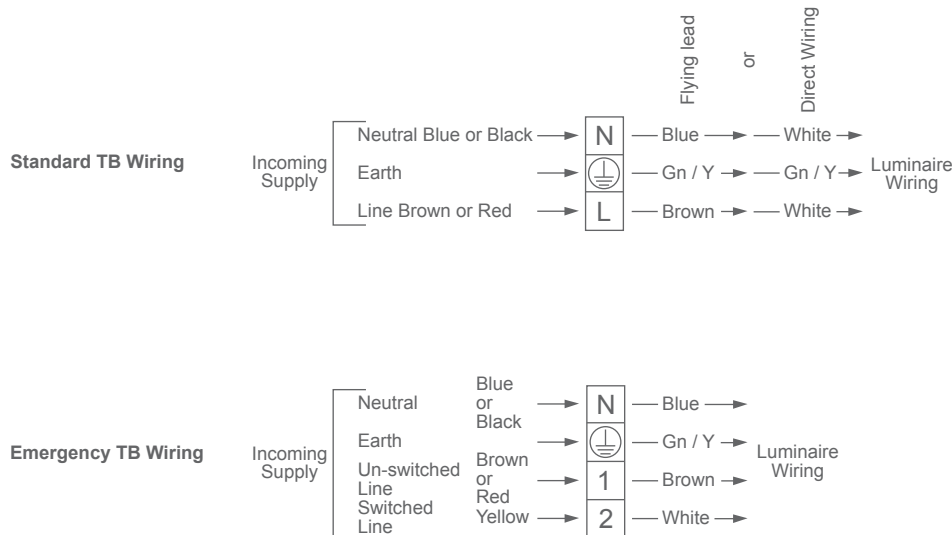

To make the fitting "Non Maintained" leave out the "Switched Line"

Close the Gear Tray (make sure that all cables are clear of the Gear Tray components) and secure with the screw provided.

Fit the lamp making sure that it is securely clipped in.

Screw on the diffuser making sure that it is correctly tightened to locate in the seal.

ADDITIONAL NOTES FOR EMERGENCY LUMINAIRES

THIS PRODUCT IS APPROVED FOR SURFACE MOUNTING ONLY

These instructions are for non-maintained, maintained and sustained emergency light fittings, which incorporate a fluorescent lamp(s).

The ballast is electronic, consisting of a high frequency inverter, battery charger, charge indicator, and battery deep discharge protection circuit.

These fittings are self-contained without "Rest Mode" facility.

All emergency versions are 3 hour duration.

The Mains supply and the Battery connection must be disconnected before servicing or maintenance.

VERY IMPORTANT

The battery connections must be left disconnected during installation if the site supply is switched off at the end of the day. Failure to do this will damage the fitting.



Trojan Round energy efficient IP65 2D luminaire

Circuits

The emergency mains supply must be connected to a direct source via a Key Switch (for test purposes only).

The switched line must be wired so that it disconnects from the luminaire if the Key Switch is switched off (no power to the fitting).

NOTE: The incoming supply earth **MUST** be connected.

NOTE: - Both luminaire supplies must be broken simultaneously (switched and unswitched) when testing.

Connections into the ballast must not exceed 2.5mm².

After connecting the mains supply, check that the charge indicator lamp (LED) is illuminated. The fluorescent lamp should operate when the luminaire is switched on (maintained and sustained only). An initial uninterrupted minimum charge period of 36 hours should always be allowed before testing the module for its rated duration.

The recommended maximum battery storage period of one year should not be exceeded.

If batteries have been left in a discharged state, one or more full charge / discharge cycles may be necessary to restore them to their normal capacity.

Stick the supplied rating label to the luminaire where it can be seen. i.e. On the base, if surface mounted. On the gear tray, if not practical to stick on the base. **MUST** not be fitted on the diffuser.



Trojan Round energy efficient IP65 2D luminaire

Routine maintenance

Routine maintenance must be carried out in compliance with the requirements of the British Standards Institute Code of Practice BS5266: Part 1 - Emergency Lighting of Premises.

The following tests assume a three-hour system

- | | | |
|-------------|---|--|
| Daily: | 1 | Check that any recorded faults have been rectified. |
| | 2 | Check that the charge indicator light is illuminated. |
| Monthly: | 1 | Check that the emergency lamp is operative. |
| | 2 | Simulate a mains failure and check that the emergency lamp illuminates immediately and remains on for three minutes. |
| | 3 | After reverting back to mains supply check the charge indicator light is illuminated. |
| Six Monthly | 1 | Simulate a mains failure and check that the emergency lamp illuminates immediately and remains on for at least one hour. |
| | 2 | After reverting back to mains supply check the charge indicator light is illuminated. |
| | 3 | On restoring the mains supply the unit will require 24 hours to recharge before becoming fully operational. |
| Annually | 1 | Simulate a mains failure and check that the emergency lamp illuminates immediately and remains on for at least 3 hours. |
| | 2 | After reverting back to mains supply check the charge indicator light is illuminated. |
| | 3 | On restoring the mains supply the unit will require 36 hours to recharge before becoming fully operational. |

It is recommended that battery packs and lamps are replaced every 4 years or sooner if the unit performance requirements fail to be met. To maintain optimum unit performance, only approved replacement battery packs and lamps must be used. All routine maintenance checks must be recorded on the unit Test Record / Installation sheet and must be made available for inspection at all times.

INSTALLATION / COMMISSIONING AND TEST RECORD	Model No		Serial No (on gear tray)	
	Type		Location	
	Installed By		Date	
	Commissioned By		Date	

Routine Test Record										
	First Year		Second Year		Third Year		Fourth Year		Fifth Year	
Monthly Test	Signed	Date	Signed	Date	Signed	Date	Signed	Date	Signed	Date
Functional										
Functional										
Functional										
Functional										
1 Hour Duration										
Functional										
Functional										
Functional										
Functional										
Functional										
1 Hour Duration										
Full Duration										



Trojan Round energy efficient IP65 2D luminaire

GENERAL ROUTINE MAINTENANCE

At commissioning and handing over of the installation, ensure that a copy of this data is presented to the authority responsible for the operation, maintenance and repair of Luminaires.

Cleaning of the Luminaire or lamp replacement must only be carried out after the fitting has been isolated from the electrical supply. **ALWAYS** check before servicing.

Cleaning should be carried out at regular intervals to ensure that contaminants do not accumulate to an extent that will impair the thermal safety of the Luminaire, or degrade the optical performance of the lamp. **DO NOT** use Spirit based cleaners.

Failed lamps must be replaced immediately, with "Lamps" of the same type, if a "Starter Switch" is fitted, this should be changed at the same time. Undetected or unattended failed lamp replacement will result in the Ballast unit overheating and ultimately will cause its' failure, rendering the fitting useless.

Notes:

This luminaire should not be modified or repaired by any persons other than those nominated by the manufacturer.

Any unauthorised modification or repair may render the luminaire unsafe and will invalidate the warranty and conformance to any safety or safety standards that may apply.

The company will accept no responsibility for any modified fittings or for any damage caused as a result of modifications. All details are given as guidance only and do not constitute a contract.

We reserve the right to change or withdraw products without notice.

Performance and Warranty

This product is warranted for twelve months from the date of installation, provided that the installation is carried out within two months of purchase, subject to the following conditions.

- This warranty will only be valid if the fittings have remained unmodified and used as per this instruction leaflet and our literature.
- Fern - Howard Ltd. shall not be liable for any consequential loss or damage caused directly or indirectly by any defective or otherwise.
- Battery packs are guaranteed for 12 months but are expected to have a life of at least four years if used within the specified temperature limits.

Disposal

The disposal of any electrical equipment, including this fitting may be subject to Local Authority Regulations and therefore should be consulted for specific guidance.

The batteries within this fitting are Nickel Cadmium and must be disposed of as per Local Authority Regulations for the disposal of toxic waste.



Trojan Round energy efficient IP65 2D luminaire

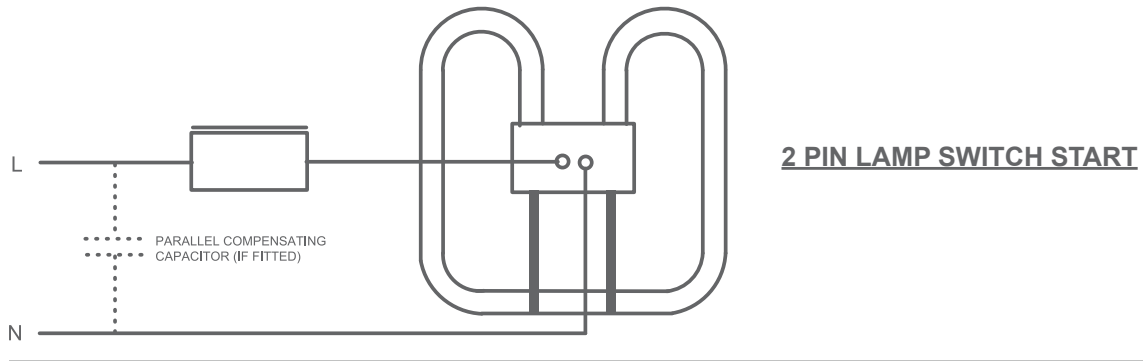

4 PIN LAMP SWITCH START

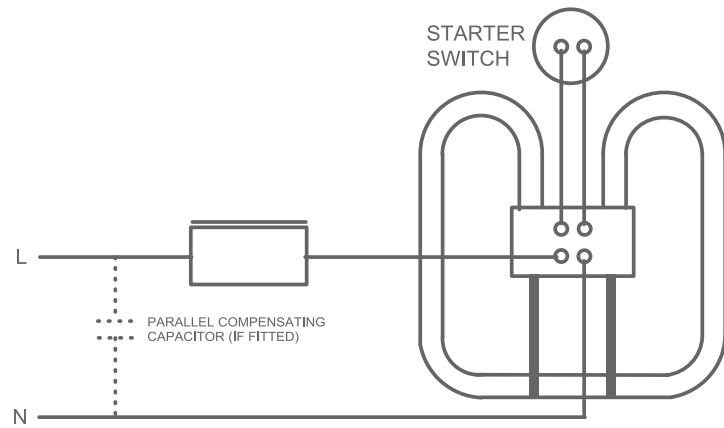

HIGH FREQUENCY

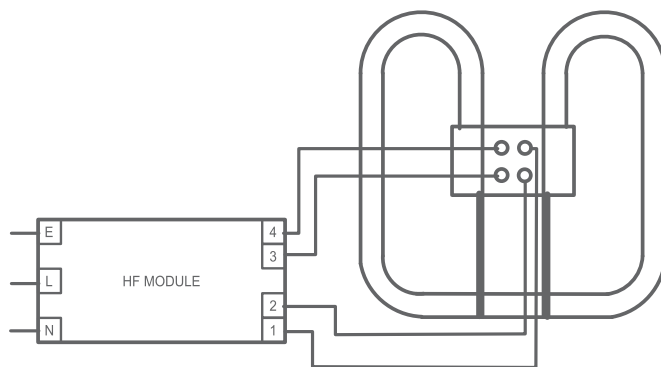

EMERGENCY MAINTAINED

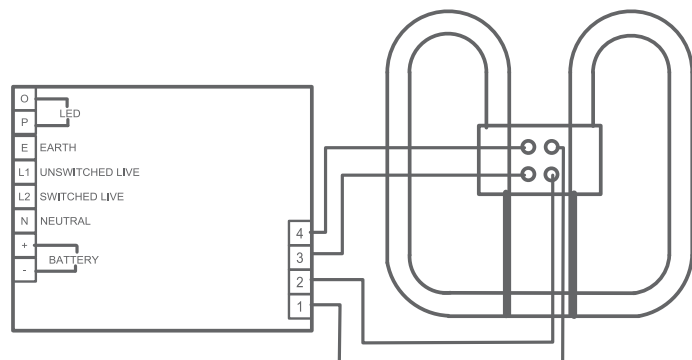



Trojan Round energy efficient IP65 2D luminaire

Lamp	Lumen Output (Mains-Mode)	Approx Lamp Life (Hrs)	MAGNETIC				HF			EM	
			Nominal Lamp Current A	Parallel Correction Capacitor	Corrected Lamp Current A	Circuit Watts Corrected	HF Current A	Circuit Watts	BLF HF	BLF Emergency Normal	BLF Emergency EM Mode
16W	1050	10,000	0.195	2uf	0.09	27.83	0.121	18.0	0.960	0.950	0.180
28W	2250	15,000	0.320	4uf	0.15	34.5	0.130	28.7	0.960	0.750	0.120
38W	3000	15,000	0.430	4uf	0.200	46.0	0.180	39.7	0.960		

Lamp	Weight	Weight HF	Weight EM
16W	1.54	1.16	2.07
28W	1.75	1.3	2.07
38W	1.9	1.37	

Lumen Output in Emergency Mode				
Lamp	Mains	EM 1Hr	EM 2Hr	EM 3Hr
16W	1050	194	190	178
28W	2250	260	260	227

Size	296mm Dia x 95 Deep
Cable Entry	Centre Rear BS Style
Body Material	Polycarbonate
Diffuser Material	Polycarbonate
Gear Tray Material	Polycarbonate
Lamp	GE 2D 3500K
Wiring	TB 2 x 2.5mm ²
Diffuser Fixing	2 Steel Screws BZP
Control Voltage	240V 50Hz

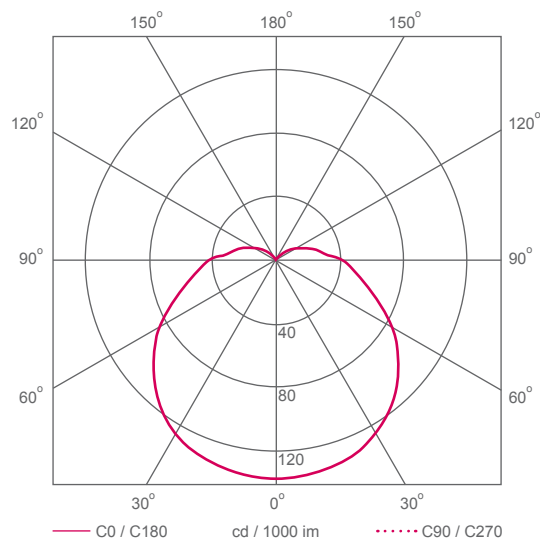

LOR = 0.63			SHR MAX = 1.60				SHR NOM = 1.50				
Room Reflectances			Room Index								
C	W	F	0.75	1.00	1.25	1.50	2.00	2.50	3.00	4.00	5.00
0.70	0.50	0.20	0.31	0.36	0.41	0.44	0.48	0.52	0.54	0.57	0.59
	0.30		0.26	0.31	0.36	0.39	0.44	0.47	0.50	0.54	0.56
	0.10		0.22	0.27	0.32	0.35	0.40	0.44	0.47	0.51	0.53
0.50	0.50	0.20	0.29	0.34	0.38	0.41	0.45	0.48	0.50	0.53	0.55
	0.30		0.25	0.29	0.34	0.37	0.41	0.44	0.47	0.50	0.52
	0.10		0.22	0.26	0.30	0.33	0.38	0.41	0.44	0.48	0.50
0.30	0.50	0.20	0.28	0.32	0.35	0.38	0.42	0.44	0.46	0.49	0.51
	0.30		0.24	0.28	0.32	0.35	0.39	0.41	0.44	0.47	0.49
	0.10		0.21	0.25	0.29	0.32	0.36	0.39	0.41	0.45	0.47
0.00	0.00	0.00	0.19	0.22	0.26	0.28	0.32	0.35	0.37	0.40	0.42

FIGURES BASED ON 28W CORRECTED SWITCHSTART FITTING